



TufTile[®]

ADA DETECTABLE WARNING PRODUCTS

GALVANIZED STEEL 16 GAUGE SURFACED-APPLIED CALIFORNIA



[TufTile.com](https://www.TufTile.com)

☎ 1-888-960-8897

📍 905 Telser Road, Lake Zurich, IL 60047

GALVANIZED STEEL



1-1/2" corrosion-resistant stainless-steel drive pins secure tiles tightly to the concrete.

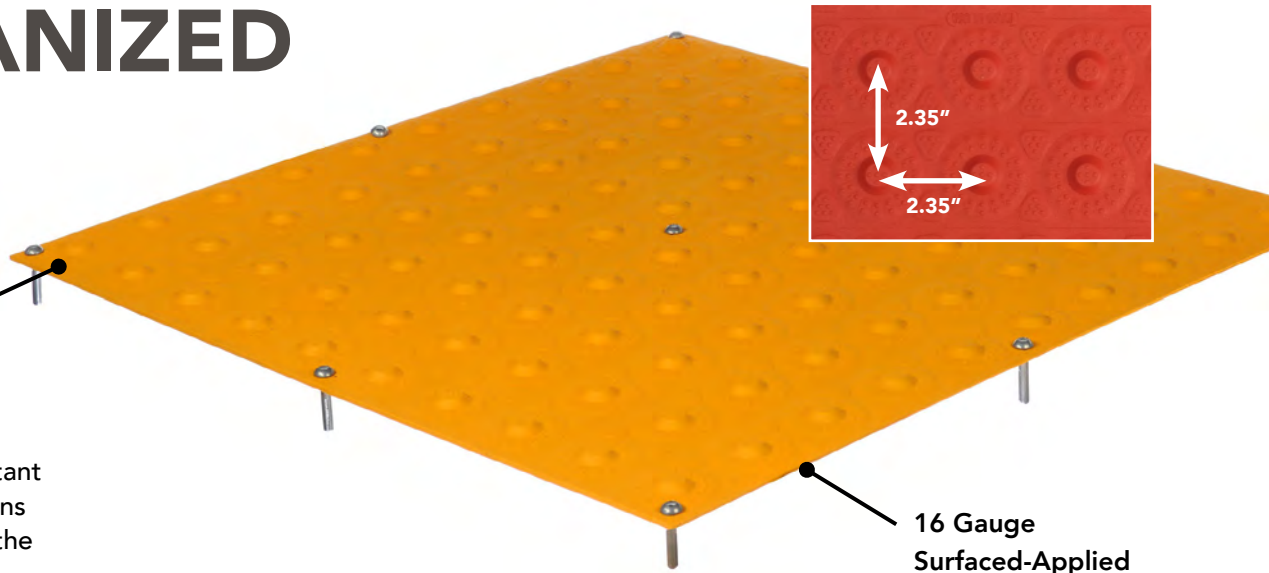

16 Gauge Surfaced-Applied

The Latest Innovation in ADA Detectable Warning Tiles

GALVANIZED BENEFITS

Half the weight of cast iron for faster and easier installation and greater shipping efficiencies.

PREMIUM PERFORMANCE

Long-term durability for heavy pedestrian traffic, high-abuse areas, and snow removal.

SUPERIOR COLOR & PROTECTION

In-house powder coating system with superior UV and slip-resistant finish.

10-YEAR WARRANTY

For full warranty information visit www.tuftile.com.

PRODUCT ASSORTMENT

Available in seven standard sizes and 20 radius capabilities 9R-70R. Single tile installations for 4' and 5' wide curb ramps. Available in wet-set and surface-applied.

STOCK ITEM

Able to meet any standard size and color order.

ADA COMPLIANT

Complies with ADA Accessibility Guidelines (ADAAG) for Public Rights-Of-Way (July 26, 2011).

Meets Buy America Act 23 C.F.R. § 635.410.



Colors Available

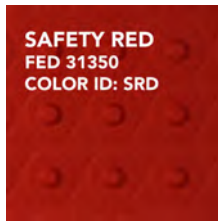
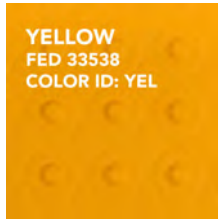

Packaging Specifications

16-Gauge Galvanized Steel Surface-Applied

Tile Size	Tile Weight/lbs.	Units/Pallet	Pallet Weight/lbs.*	Wedge Size	Wedge Weight/lbs.
1'x1'	2.5	48	147	15R Wedge	1.5
2'x1'	5.5	48	293	20R Wedge	1.25
2'x2'	10	48	528	25R Wedge	1
2'x3'	16.5	24	397	30R Wedge	1
2'x4'	21	24	528		
2'x5'	26	24	656		
3'x1'	7.5	48	385		

* Note: Pallet weight will vary if top-loaded with wedges

Surface-Applied Fastening System



Sealant



1/4"
Carbide Tipped
Masonry Bit



1-1/2"
Drive Pin

PHYSICAL CHARACTERISTICS GALVANIZED STEEL

Dome Geometry

ADA (R305.1.1) specifies truncated domes shall have a base diameter of 0.9" minimum, a top diameter of 50%-65% of the base diameter minimum, and height of 0.2".

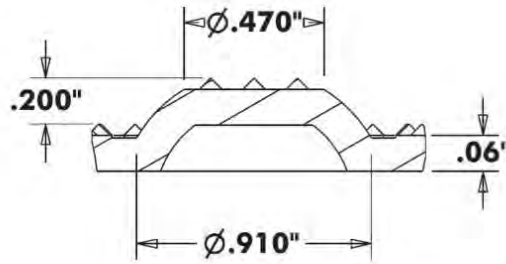

SECTION A-A

Dome Spacing

ADA (R305.1.2) specifies truncated domes shall have a center-center of 1.6" to 2.4".

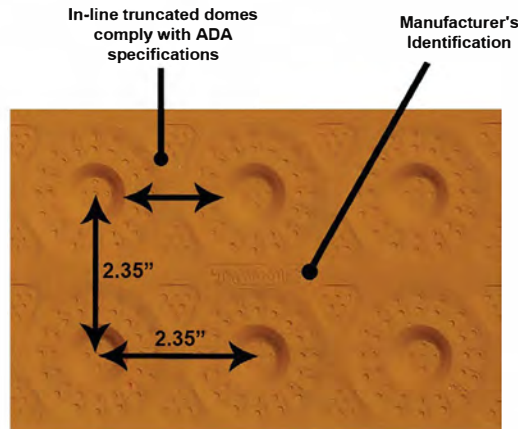

Galvanized Steel Test Data

Galvanization	G90 Guardrail Grade	G90
ASTM C 501	Abrasion Resistance	0.005
FDOT FM 3 - C 1028	Slip Resistance	Dry - 0.90, Wet - 0.81
ASTMA A 370	Tensile Strength	49,770 psi
ASTM D 695	Compressive Properties	55,170 psi
ASTM E 84-18 ANSI/UL723	Test for Surface Burning Characteristics	CFS - 0.00, FSI - 0, CSD - 5.8, SDI - 5

BUY AMERICA ACT CERTIFICATION

By law, America manufactured products must be used in all Federal Transportation projects and all state and local government projects that use Federal Transportation funds.

The Buy America provision of the law explicitly requires steel, cast iron, and polymer-based products manufactured in United States mills, foundries, and other production facilities are used in Federal Transportation infrastructure projects. Under the various "Buy America" definitions, the following are those that we comply with:

- American Recovery and Reinvestment Act of 2009, Section 1605 – Buy America Act
- Infrastructure Investment and Jobs Act (IIJA; P.L. 117-58) November 2021
- Federal Highway Administration, 23 U.S.C. § 313 – Buy America; 23 C.F.R. § 635.410
- Federal Transit Administration, 49 U.S.C. § 5323(j)(1); 49 C.F.R. Part 661
- Federal Aviation Administration, 49 U.S.C. §50101

TufTile galvanized steel, cast iron, and polymer detectable warning tiles and radius-wedges are manufactured in the United States from United States made materials in accordance with Buy America, 23 C.F.R § 635.410 requirements.



Ted Meyers
President



GALVANIZED STEEL SAFETY DATA SHEET (SDS)



SECTION I: MATERIAL IDENTIFICATION

PRODUCT NAME: Galvanized Steel
CHEMICAL FAMILY: Iron, Manganese, Chromium, Silicon, Nickel, Vanadium, Zinc
MANUFACTURER: Steel Dynamics, Inc., Butler, IN 46721
CONTACT ADDRESS: TufTile® 905 Telser Rd., Lake Zurich, IL 60047
PHONE: (888) 960-8897

SECTION II: COMPOSITION/INFORMATION ON INGREDIENTS

Hazardous Components: None in solid form
Composition: Iron (Fe), Manganese (Mn), Chromium (Cr), Silicon (Si), Nickel (Ni), Vanadium (V), Zinc (Zn)
Melting Temperature: 2750 Degrees Fahrenheit

SECTION III: PHYSICAL CHARACTERISTICS

Emergency Overview: This material is NOT HAZARDOUS by OSHA
Appearance and Odor: Solid Mass, No Odor
Specific Gravity: 7.80 g/cc
Freezing Point: N/A
Solubility in Water: N/A
% Volatile by Volume: N/A
Boiling Point: ND
pH: N/A

SECTION IV: FIRE AND EXPLOSION INFORMATION

Flammability: Non-flammable, non-combustible
Means of Extinction: N/A
Special Procedures: None
Explosion Data: None Known
Sensitivity of Mechanical impact: None
Hazardous Combustion: None Known
Auto ignition Temp: N/A
Sensitivity to Static: N/A

SECTION V: HEALTH HAZARD DATA

Permissible Exposure: N/A for product (See Section II above)

SECTION VI: REACTIVITY DATA

Chemical Stability: Steel products are stable under normal storage and handling conditions.
Reactivity: Not Determined (ND) for product in a solid form.

SECTION VII: SPILL OR LEAK PROCEDURES

Spill: None (Solid Mass Product)
Waste Disposal: Recycle or Recover if possible

SECTION VIII: PROTECTIVE EQUIPMENT TO BE USED:

Protective Gloves: Wear protective gloves / protective clothing
Eye Protection: Wear safety glasses with side shields when cutting tiles

SECTION IX: LEGAL DISCLAIMER

The above information is based on the data of which we are aware and is believed to be correct as of the date hereof. Since this information may be applied under conditions beyond our control and with which may be unfamiliar and since data made available subsequent to the date hereof may suggest modifications of the information, we do not assume any responsibility for the results of its use. This information is furnished upon condition that the person receiving it shall make his own determination of the suitability of the material for his particular purpose.



16 GAUGE GALVANIZED STEEL SURFACE-APPLIED INSTALLATION INSTRUCTIONS

Read installation instructions thoroughly before you begin.

For Federal compliance documents [click here](#).

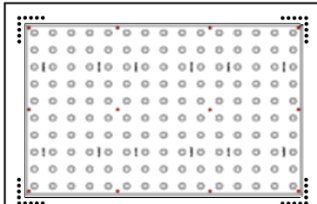

Fig. 1

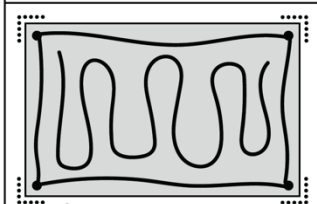

Fig. 2

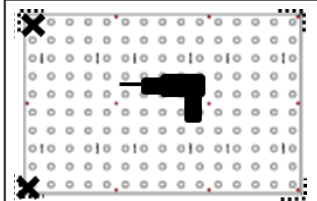

Fig. 3a

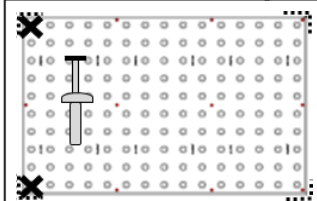

Fig. 3b

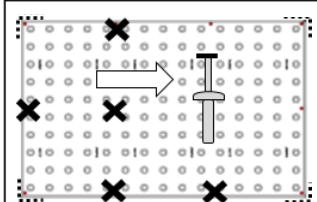

Fig. 4

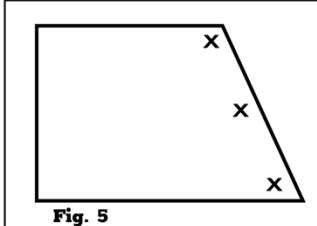

Fig. 5

1. Surface must be clean and free of debris before beginning. A wire brush or cup grinder may be needed to address any imperfections.
2. Place tile on surface where it is to be installed and mark the corners. (Fig. 1)
3. Remove and apply sealant to the back side of the tile as required. (Fig. 2)
NOTE: Use sealant according to manufacturer's recommendation.
4. Place tile in marked location. Using a 1/4" masonry bit, drill 2" minimum deep holes (Fig. 3a) and insert 2 drive pin fasteners. (Fig. 3b) **NOTE: Do not drive pins in yet as they are to keep tile in place while drilling remaining holes.**
5. Continue drilling holes in the anchor locations going across the tile. (For surface applied use center most holes in the field.) Once all holes are drilled, clean the tile with a broom or industrial shop vac before inserting the remaining drive pins. [Click here](#) for information on OSHA standard §1926.1153 Respirable Crystalline Silica.
6. Insert drive pins in all remaining holes and hammer them in moving across the tile in one direction. (Fig. 4) **NOTE: Only drive the pin so that it is even with the head of the anchor.**

IMPORTANT: WHEN INSTALLING MULTIPLE LINEAR TILES, A 1/8" SPACE IS REQUIRED TO ALLOW FOR EXPANSION.



NOTE: If a tile is cut, new holes need to be drilled and anchors inserted along the edge. (Fig. 5)

Installation is now complete.

Radius TufTile® Installation

Place tiles and radius wedge pieces on the surface. Once you're satisfied with the layout, continue with steps 2-6 above.

NOTE: Any adjustments needed should be done before fastening the tiles.

[Click here](#) for more information including an installation video tutorial.

Contact us at 888-960-8897 with questions.



ACERO GALVANIZADO CALIBRE 16 APLICACIÓN SUPERFICIAL INSTRUCCIONES DE INSTALACIÓN

Lea por completo las instrucciones de instalación antes de empezar.

Haga clic aquí para los documentos de cumplimiento federal.

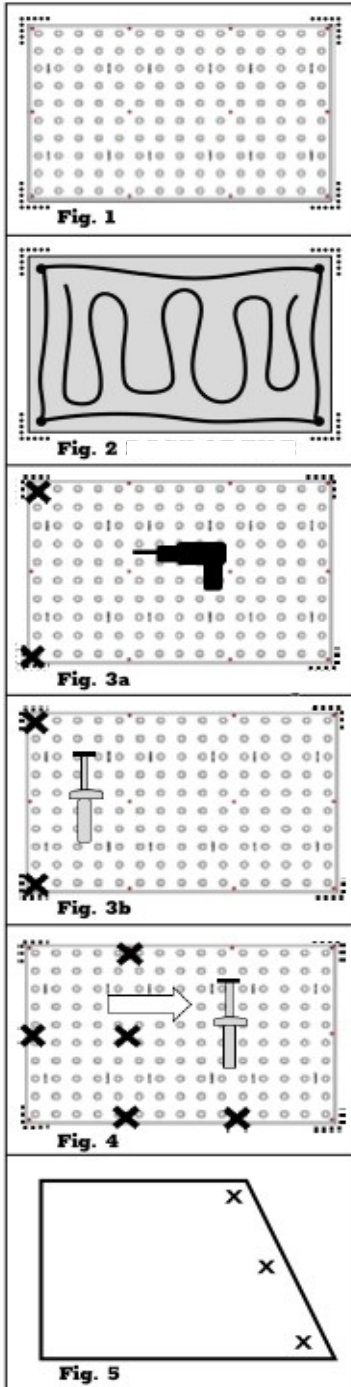

1. La superficie debe estar limpia y libre de suciedad antes de empezar. Puede ser necesario usar un cepillo de alambre o una amoladora de hormigón para eliminar imperfecciones.
2. Ponga la baldosa sobre la superficie donde será instalada y marque las esquinas. (Fig. 1)
3. Levántela y póngale un pegamento en el lado posterior de la baldosa como sea necesario. (Fig. 2) **NOTA:** Use el pegamento según las instrucciones del fabricante.
4. Ponga la baldosa en su ubicación marcada. Con una broca para mampostería de 1/4", haga hoyos de un mínimo de 2" (Fig. 3a) e inserte dos pasadores de impulsión. (Fig. 3b) **NOTA:** No insertar los pasadores todavía ya que sirven para mantener la baldosa en su lugar mientras haga los demás hoyos.
5. Continúe haciendo hoyos en los puntos de anclaje a lo largo de la baldosa. (Para superficie aplicado use los hoyos más hacia el centro.) Una vez hechos los hoyos, limpie la baldosa con una escoba o aspiradora industrial antes de insertar el resto de los pasadores. **Haga clic aquí** para más información sobre el estándar OSHA §1926.1153 Respirable Crystalline Silica.
6. Inserte los pasadores de impulsión en todos los hoyos y martíllelos moviéndolos a través de la baldosa en una sola dirección. (Fig. 4) **NOTA:** Martille el pasador sólo hasta que esté parejo con la cabeza del anclaje.
IMPORTANTE: ES NECESARIO DEJAR UN ESPACIO DE 1/8" ENTRE LAS BALDOSAS CUANDO SE INSTALEN MÚLTIPLES BALDOSAS LINEARES PARA PERMITIR EXPANSIÓN.



NOTA: Si se corta una baldosa hay que hacer hoyos nuevos e insertar más pasadores a lo largo del borde. (Fig. 5)

La instalación ya está completa.

Instalación de Radio TufTile®

Ubique las baldosas y las piezas cuñas sobre la superficie. Una vez satisfecho con el montaje, siga con los pasos 2-6 de arriba.

NOTA: Haga cualquier ajuste al montaje antes de fijar las baldosas.

Haga clic aquí para más información incluyendo un video tutorial de la instalación.

Llámenos al 888-960-8897 con sus preguntas.



STATE OF CALIFORNIA GALVANIZED STEEL RAMP LAYOUT

RAMP SIZE

3' x 4'



TILE SIZE

36\" x 24\"

QUANTITY

2

RAMP SIZE

3' x 5'

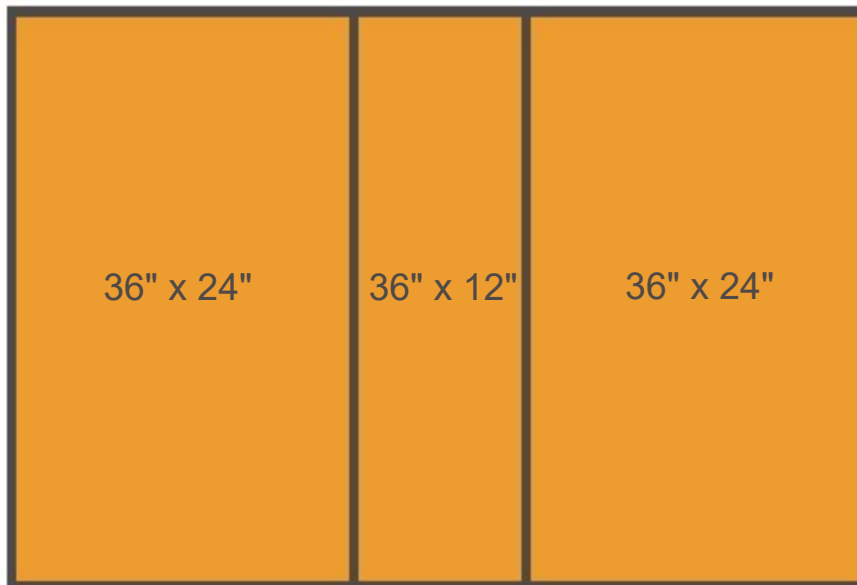

TILE SIZE QUANTITY

36\" x 24\"

2

36\" x 12\"

1

12" X 12" X 16 GA (REPLACEABLE)

GALVANIZED STEEL DETECTABLE WARNING TILE

2.350 DOME SPACING

TufTile®

DRW NO	GV121216-XX-XXX	DRAWN	GM	DATE	12-30-20
TOLERANCE	+/- 0.050	SCALE		REV	DATE

NOTES:

"XX" WS DESIGNATES WET SET

"XX" SA DESIGNATES SURFACE APPLIED

"XXX"DESIGNATES COLOR

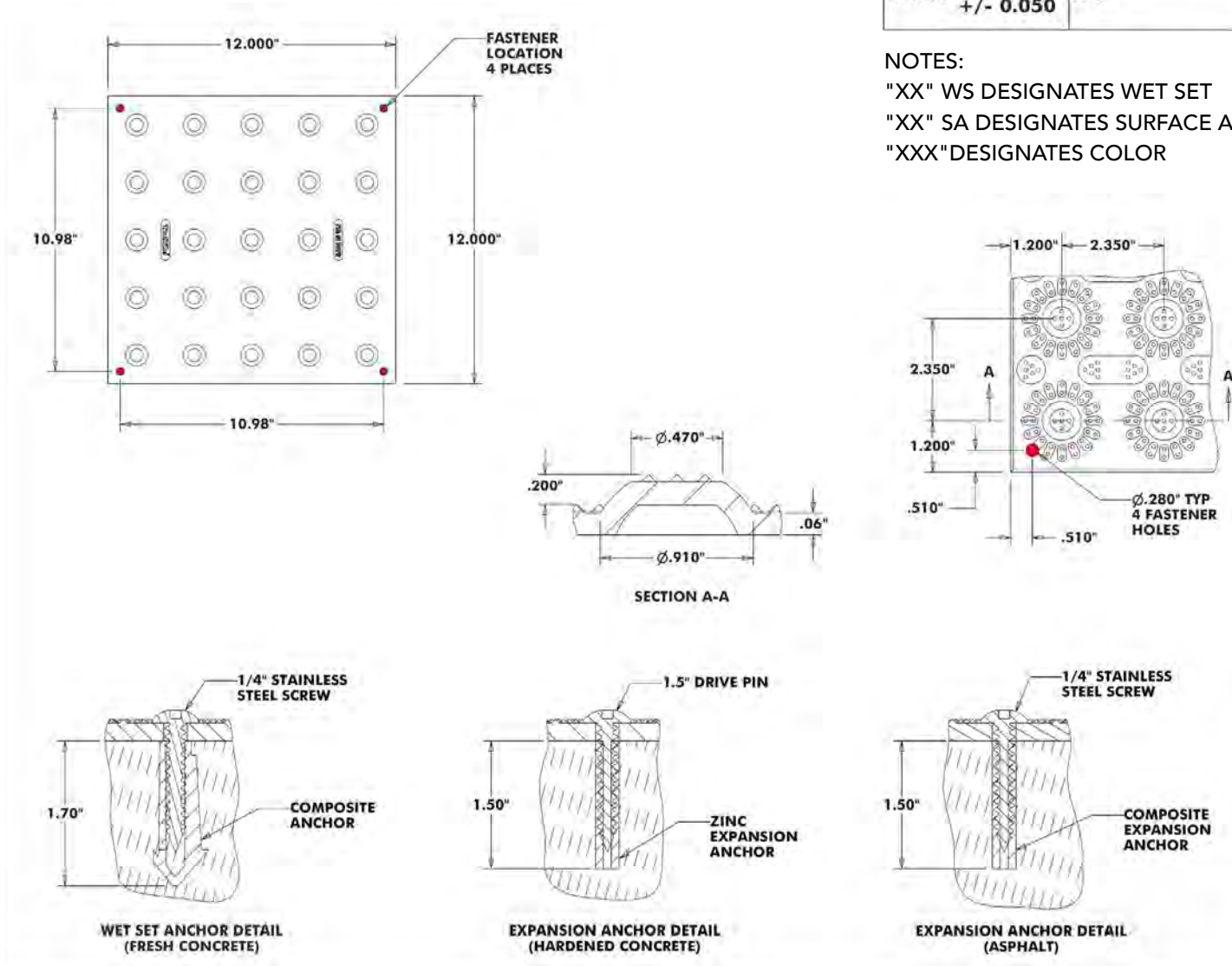

36" X 12" X 16 GA (REPLACEABLE)

GALVANIZED STEEL DETECTABLE WARNING TILE

2.350 DOME SPACING



DRW NO	GV361216-XX-XXX	REVISED	GM	12-30-20
TOLERANCE	+/- 0.050	SCALE	REV	DATE

NOTES:

"XX" WS DESIGNATES WET SET

"XX" SA DESIGNATES SURFACE APPLIED

"XXX" DESIGNATES COLOR

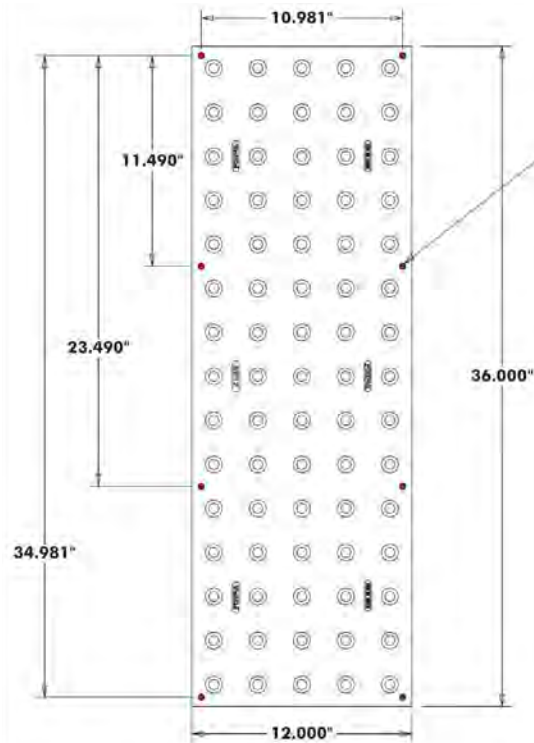

FASTENER LOCATION
8 PLACES

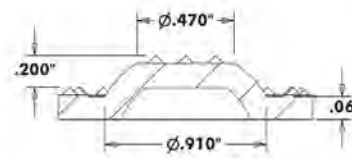

SECTION A-A

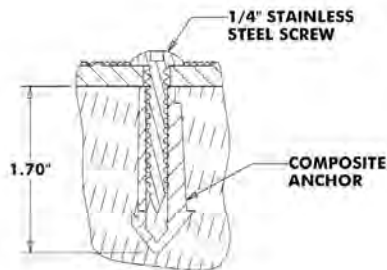
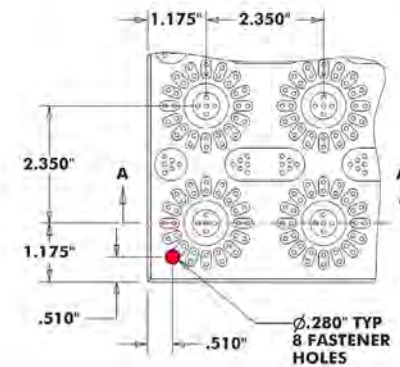

WET SET ANCHOR DETAIL
(FRESH CONCRETE)

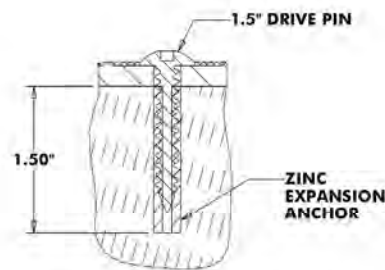

EXPANSION ANCHOR DETAIL
(HARDENED CONCRETE)

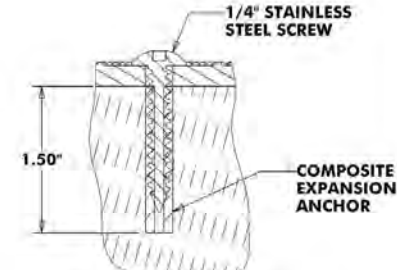

EXPANSION ANCHOR DETAIL
(ASPHALT)



36" X 24" X 16 GA (REPLACEABLE)

GALVANIZED STEEL DETECTABLE WARNING TILE

2.350 DOME SPACING



DRW NO	GV362416-XX-XXX	REVISED	GM	12-30-20
TOLERANCE	+/- 0.050	SCALE	REV	DATE

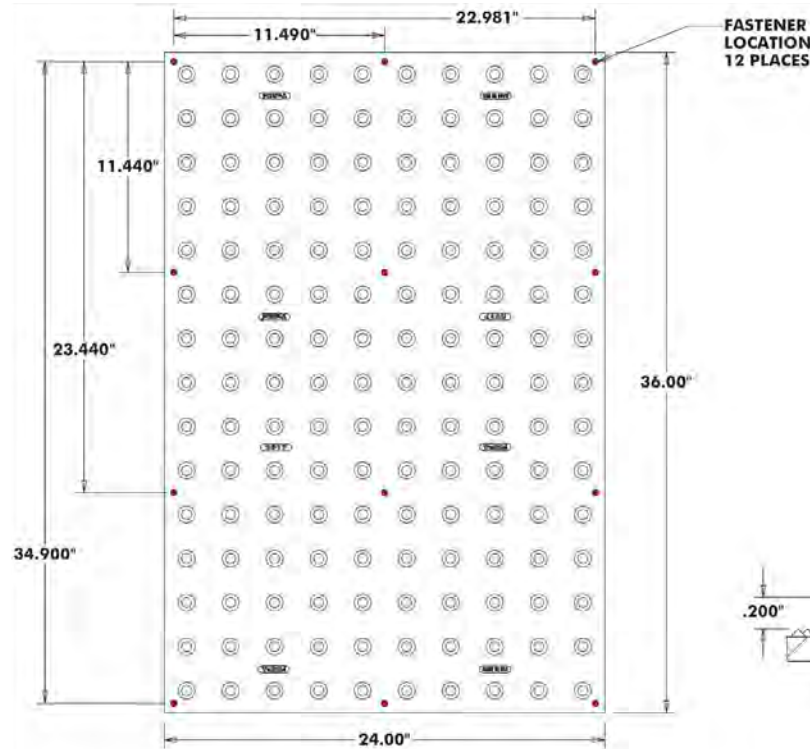

NOTES:

"XX" WS DESIGNATES WET SET

"XX" SA DESIGNATES SURFACE APPLIED

"XXX" DESIGNATES COLOR

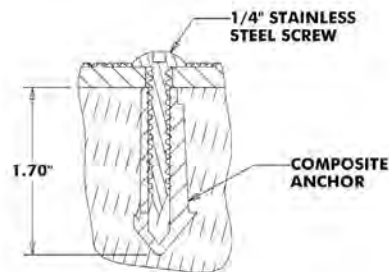
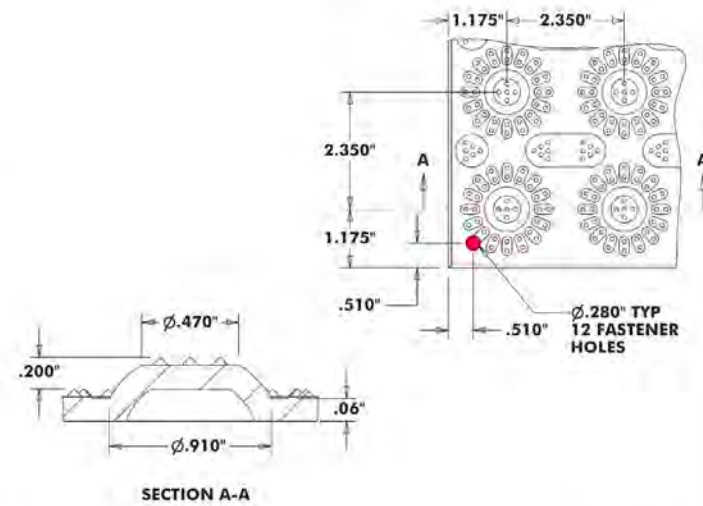

WET SET ANCHOR DETAIL (FRESH CONCRETE)

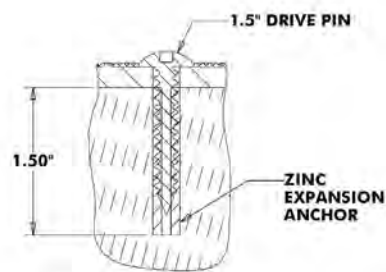

EXPANSION ANCHOR DETAIL (HARDENED CONCRETE)

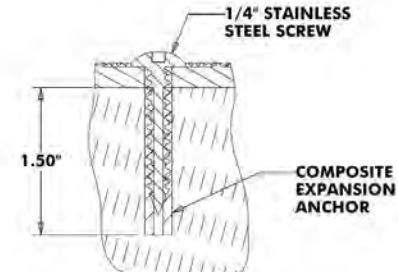

EXPANSION ANCHOR DETAIL (ASPHALT)



36" X 48" X 16 GA (REPLACEABLE)

GALVANIZED STEEL DETECTABLE WARNING TILE

2.350 DOME SPACING



DRW NO	GV364816-XX-XXX	DRAWN	GM	DATE	12-30-20
TOLERANCE	+/- 0.050	SCALE		REV	DATE

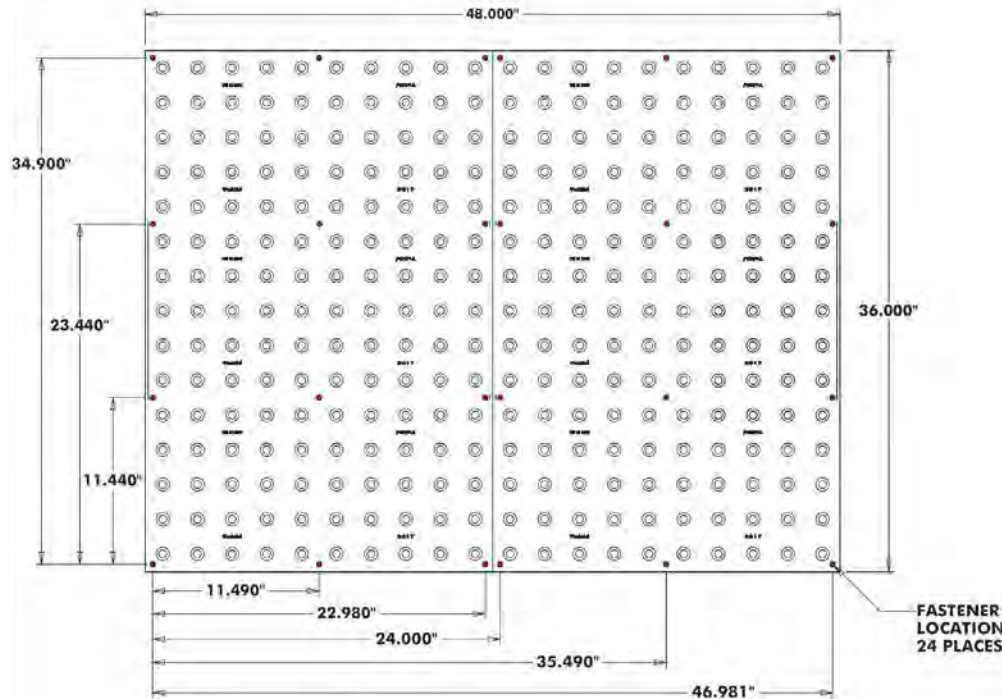

NOTES:

"XX" WS DESIGNATES WET SET

"XX" SA DESIGNATES SURFACE APPLIED

"XXX" DESIGNATES COLOR

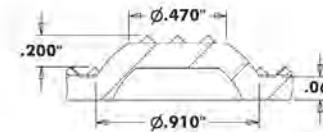
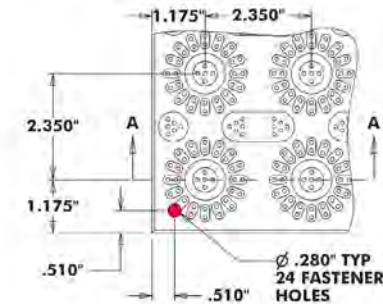

SECTION A-A

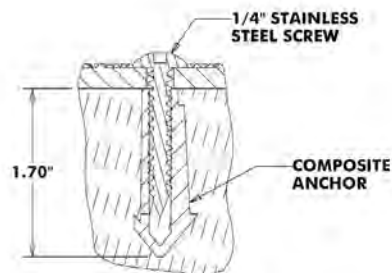

WET SET ANCHOR DETAIL (FRESH CONCRETE)

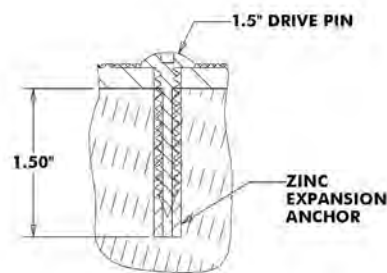

EXPANSION ANCHOR DETAIL (HARDENED CONCRETE)

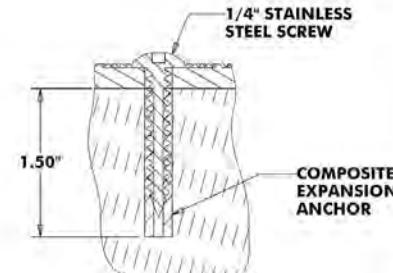

EXPANSION ANCHOR DETAIL (ASPHALT)



36" X 60" X 16 GA (REPLACEABLE)

GALVANIZED STEEL DETECTABLE WARNING TILE

2.350 DOME SPACING



DRW NO	GV366016-XX-XXX	DRAWN	GM	DATE	12-30-20
TOLERANCE	+/- 0.050	SCALE		REV	DATE

NOTES:

"XX" WS DESIGNATES WET SET

"XX" SA DESIGNATES SURFACE APPLIED

"XXX" DESIGNATES COLOR

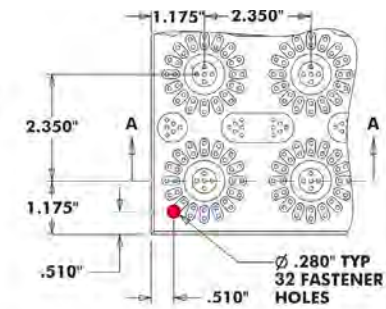
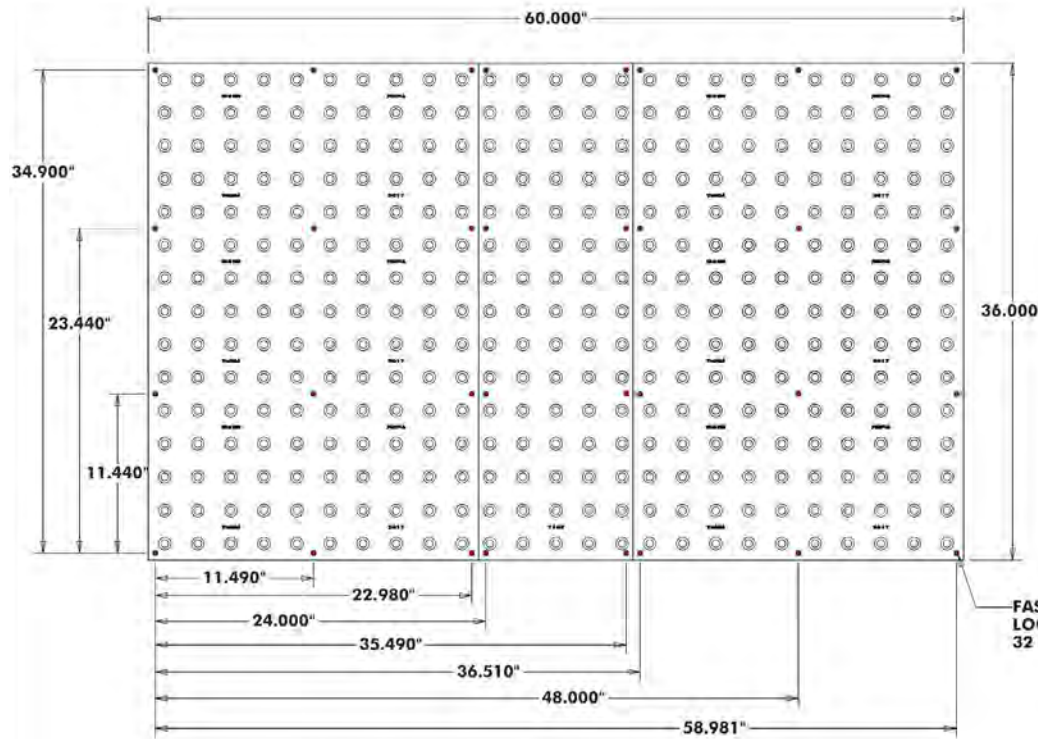

FASTENER LOCATION
32 PLACES

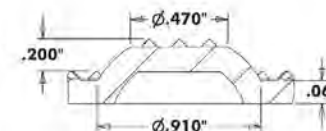

SECTION A-A

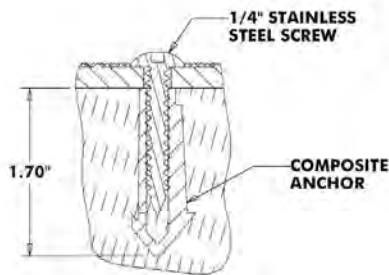

WET SET ANCHOR DETAIL
(FRESH CONCRETE)

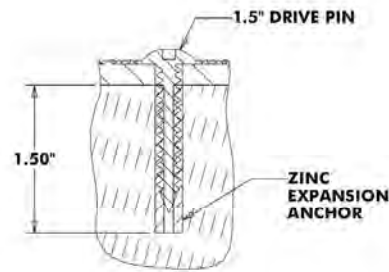

EXPANSION ANCHOR DETAIL
(HARDENED CONCRETE)

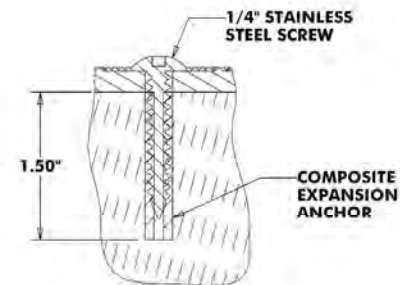

EXPANSION ANCHOR DETAIL
(ASPHALT)



GALVANIZED STEEL 10-YEAR LIMITED WARRANTY

TufTile, Inc. values your business, and the TufTile, Inc. tactile galvanized steel tile (the “product”) you purchased comes with a limited warranty that the product will be free from defects for a period of ten years from date of installation subject to ordinary wear and tear. Failure to comply with recommended applications and installation of the product voids this warranty. Surface applied installations in snow removal regions are not covered in this warranty. Customer misuse including negligence, physical abuse and defects resulting from improper installation or resulting from outside forces (including, but not limited to, snow plows causing damage) are not covered by this warranty. Modifying galva-nized tiles by way of cutting the tile may expose the cut edge area to rust. Modified tiles however, will remain structurally sound and cutting tiles will not impact the lifespan of the tile. Also, the rust at the exposed edge of the tile will not migrate under the powder coat finish. Local building codes may require minimum tactile tile performance specifica-tions. TufTile, Inc. does not warrant product installations that violate building codes. While within the limited warranty period, if the product is not in good working order for its intended purposes, a replacement product shall be made available to the purchaser of the product. Purchaser’s remedy is limited to replacement of the product and no consequential or incidental damages and costs (including, but not limited to, lost profits, labor or transportation costs in connection with the removal, replacement and installation of the product) are recoverable or within the coverage of this limited warranty. Any representations made in connection with the sale of this product that differs from the terms of this limited warranty are not covered and should be brought to the attention of TufTile, Inc. immediately. No claim for replacement of a defective product will be honored without TufTile, Inc.’s reservation of its right to inspect the product for the claimed defect and its determination that the replacement of the product is covered by this warranty. The term of this limited warranty shall commence on the date of installation. Proof of purchase shall be required to be eligible for this warranty and to establish the commencement date of this limited warranty. No warranty replacement of the product is provided unless the purchaser’s written replacement claim is submitted to TufTile, Inc. before the expiration of ten years from the date of installation of the product.

CALTRANS 5-YEAR LIMITED WARRANTY

TufTile, Inc. further warrants to the purchaser, Caltrans, or any assignee against defects in materials and workmanship of dome shape, color fastness, sound-on-cane acoustic quality, resilience, and attachment for a period of five (5) years from date of installation. The remedy for product noncompliance with this warranty shall be repair or replacement of the product, whichever is reasonably determined within assignee’s sole discretion. This warranty is assignable without limitation or derogation of any representations, other warranties, or any other obligations. This warranty is governed under the laws of the State of California.

TO THE MAXIMUM EXTENT APPLICABLE AND ALLOWABLE UNDER LAW, THERE ARE NO WARRANTIES WHICH EXTEND BEYOND THE FACE OF THE TUFTILE INC. LIMITED WARRANTY, AND TUFTILE INC. DISCLAIMS ALL OTHER WARRANTIES, EXPRESS OR IMPLIED, REGARDING THE PRODUCT, INCLUDING ANY IMPLIED WARRANTIES OF MERCHANTABILITY, FITNESS FOR A PARTICULAR PURPOSE OR NONINFRINGEMENT. TO THE MAXIMUM EXTENT ALLOWABLE BY FEDERAL AND STATE LAW, THIS WARRANTY SUPPLEMENTS OR SUPERSEDES FEDERAL AND STATE CONSUMER GOODS WARRANTY PROTECTION.

California Department of Transportation Detectable Warning Surface Authorized Material List

The following products have been found acceptable for use on State Highway Contracts

Vendor	Product Name	Expiration
TufTile, Inc 1200 Flex Ct. Lake Zurich, IL 60047	Galvanized/Powder Coated Cast-in-Place (replaceable) Steel Tile	Nov 17, 2025
Don Kimble 847-307-3070 don@tufTile.com www.tufTile.com	Galvanized/Powder Coated Surface-Applied Steel Tile	
	Cast Iron/Powder Coated Cast-in-Place (replaceable Tile)	

For additional information, please send email to rebecca.mowry@dot.ca.gov

Revised November 17, 2022



COMPLIANCE CERTIFICATION

TufTile®, Inc. certifies that TufTile Galvanized Steel tiles are in compliance with the following:

Americans with Disabilities Act (ADA) (42.U.S.C. 12101 et seq.) (Title III Regulations, 28 CFR Part 36 ADA STANDARDS FOR ACCESSIBLE DESIGN, Appendix A, Section 4.29.2 DETECTABLE WARNINGS ON WALKING SURFACES) and ADA Accessibility Guidelines (ADAAG) for Public RightsOf-Way (July 26, 2011).

California Code of Regulations (CCR) Title 24, Chapter 2, Section 202 definition of "Detectable Warning". Section 118-247 and 118-705 "Detectable Warnings and Detectable Directional Warning Texture"

Additional information on our products and services can be found on our web site www.tuftile.com or call us directly.



Don Kimble
ADA Compliance Manager
TufTile, Incorporated
don@tuftile.com

FEDERAL LAW & DETECTABLE WARNING SURFACES

The Americans with Disabilities Act (ADA) (42 U.S.C. 12101 et seq.) is a federal civil rights law that prohibits discrimination against individuals with disabilities. The regulations issued by the Department of Justice include accessibility standards for the design, construction, and alteration of facilities. One of those requirements requires installation of detectable warning surfaces as described in these sections of the ADA Accessibility Guidelines (ADAAG) for Public Rights-Of-Way (July 26, 2011). To view the entire proposed guidelines document, go to www.access-board.gov.

R305.1.1 Dome Size

The truncated domes shall have a base diameter of 23 mm (0.9 in) minimum and 36 mm (1.4 in) maximum, a top diameter of 50 percent of the base diameter minimum and 65 percent of the base diameter maximum, and a height of 5 mm (0.2 in).

R305.1.2 Dome Spacing

The truncated domes shall have a center-to-center spacing of 41 mm (1.6 in) minimum and 61 mm (2.4 in) maximum, and a base-to-base spacing of 17 mm (0.65 in) minimum, measured between the most adjacent domes.

R305.1.3 Contrast

Detectable warning surfaces shall contrast visually with adjacent gutter, street or highway, or pedestrian access route surface, either light-on-dark or dark-on-light.

R305.1.4 Size

Detectable warning surfaces shall extend 610 mm (2.0 ft) minimum in the direction of pedestrian travel. At curb ramps and blended transitions, detectable warning surfaces shall extend the full width of the ramp run (excluding any flared sides), blended transition, or turning space. At pedestrian at-grade rail crossings not located within a street or highway, detectable warnings shall extend the full width of the crossing. At boarding platforms for buses and rail vehicles, detectable warning surfaces shall extend the full length of the public use areas of the platform. At boarding and alighting areas at sidewalk or street level transit stops for rail vehicles, detectable warning surfaces shall extend the full length of the transit stop.

R305.2 Placement

The placement of detectable warning surfaces shall comply with R305.2.

R305.2.1 Perpendicular Curb Ramps

On perpendicular curb ramps, detectable warning surfaces shall be placed as follows:

1. Where the ends of the bottom grade break are in front of the back of curb, detectable warning surfaces shall be placed at the back of curb.
2. Where the ends of the bottom grade break are behind the back of curb and the distance from either end of the bottom grade brake to the back of curb is 1.5 m (5.0 ft) or less, detectable warning surfaces shall be placed on the ramp run within one dome spacing of the bottom grade break.
3. Where the ends of the bottom grade break are behind the back of curb and the distance from either end of the bottom grade brake to the back of curb is more than 1.5 m (5.0 ft), detectable warning surfaces shall be placed on the lower landing at the back of curb.

R305.2.2 Parallel Curb Ramps

On parallel curb ramps, detectable warning surfaces shall be placed on the turning space at the flush transition between the street and sidewalk.

R305.2.3 Blended Transitions

On blended transitions, detectable warning surfaces shall be placed at the back of curb. Where raised pedestrian street crossings, depressed corners, or other level pedestrian street crossings are provided, detectable warning surfaces shall be placed at the flush transition between the street and the sidewalk.

R305.2.4 Pedestrian Refuge Islands

At cut-through pedestrian refuge islands, detectable warning surfaces shall be placed at the edges of the pedestrian island and shall be separated by a 610 mm (2.0 ft) minimum length of surface without detectable warnings.

R305.2.5 Pedestrian At-Grade Rail Crossings

At pedestrian at-grade rail crossings not located within a street or highway, detectable warning surfaces shall be placed on each side of the rail crossing. The edge of the detectable warning surface nearest the rail crossing shall be 1.8 m (6.0 ft) minimum and 4.6 m (15.0 ft) maximum from the centerline of the nearest rail. Where pedestrian gates are provided, detectable warning surfaces shall be placed on the side of the gates opposite the rail.

R305.2.6 Boarding Platforms

At boarding platforms for buses and rail vehicles, detectable warning surfaces shall be placed at the boarding edge of the platform.

R305.2.7 Boarding and Alighting Areas

At boarding and alighting areas at sidewalk or street level transit stops for rail vehicles, detectable warning surfaces shall be placed at the side of the boarding and alighting area facing the rail vehicles.